

Leistungsschalter Manual Motor Starter

M4-32T / M4-32R
M4-63R
M4-100R / M4-100RH



⚠ WARNING



WARNUNG

Montage, Anschluß und Inbetriebnahme des Gerätes muß entsprechend den Sicherheitsvorschriften erfolgen und darf nur von qualifiziertem Personal ausgeführt werden.

WARNING

To prevent electrical shock, disconnect power from source before installing or servicing. And must be carried out by qualified personnel.

Beachten Sie, dass vor Ein- oder Ausbau des Gerätes der Griff in OFF- Stellung ist.

Make sure that the handle is in the OFF position before installing or uninstalling the accessory.

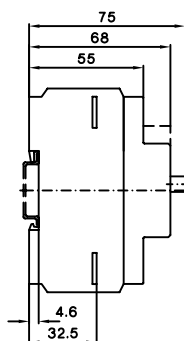
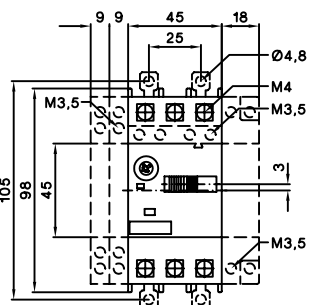

TYPE	[A]	BEREICH / RANGE
M4-32T	0.16 A	0.1-0.16A
M4-32R	0.25 A	0.16-0.25A
	0.4 A	0.25-0.4A
	0.63 A	0.4-0.63A
	1 A	0.63-1A
	1.6 A	1-1.6A
	2.5 A	1.6-2.5A
	4 A	2.5-4A
	6 A	4-6A
	8 A	5-8A
	10 A	6-10A
	13 A	9-13A
	17 A	11-17A
	22 A	14-22A
	26 A	18-26A
	32 A	22-32A

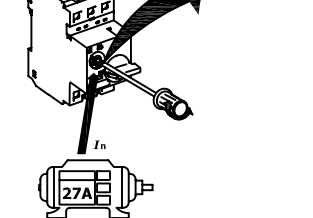
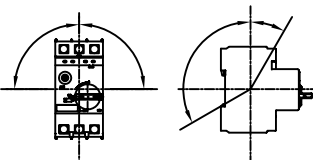
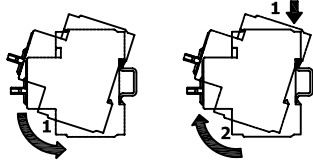
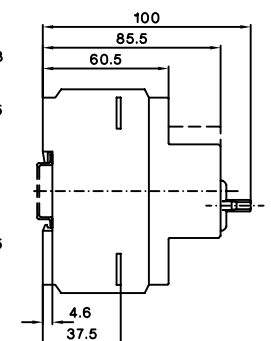
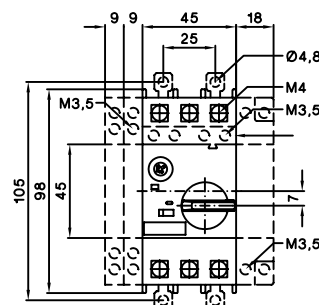

VAC / VDC

Bei einphasigem Betrieb müssen alle 3 Phasen in Serie geschaltet werden.

For single-phase applications, the three poles have to be connected in series.

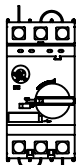

TYPE	[A]	BEREICH RANGE
M4-63R	10A	6-10A
	13A	9-13A
	17A	11-17A
	22A	14-22A
	26A	18-26A
	32A	22-32A
	40A	28-40A
	50A	34-50A
	63A	45-63A

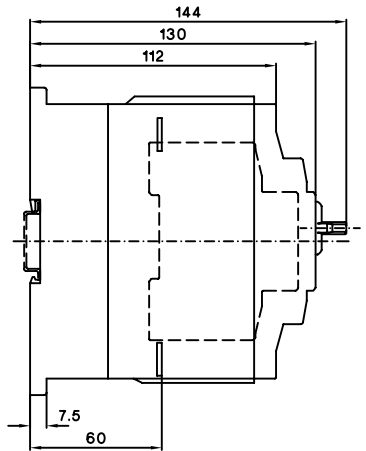
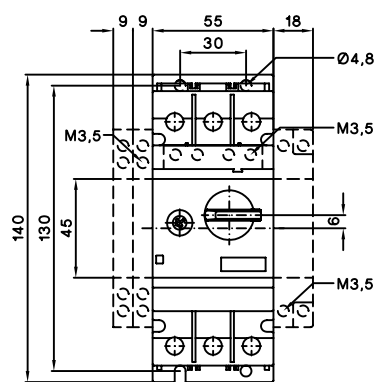

TYPE	[A]	BEREICH RANGE
M4-100R	17A	11-17A
M4-100RH	22A	14-22A
	26A	18-26A
	32A	22-32A
	40A	28-40A
	50A	34-50A
	63A	45-63A
	75A	55-75A
	90A	70-90A
	100A	80-100A

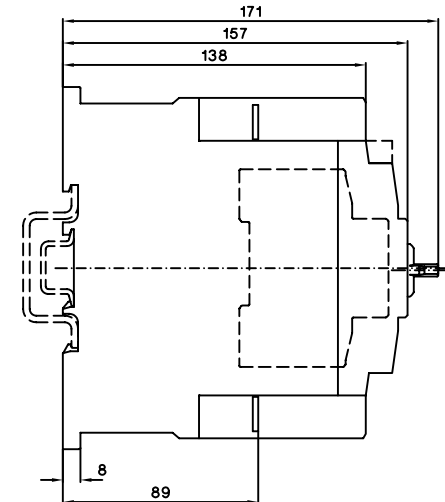
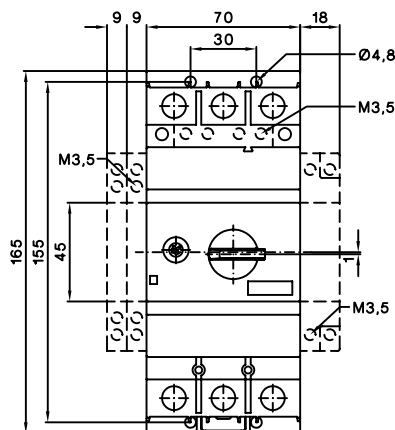

Installation

- M4-32T
- M4-32R

Für / for M4 HS..

- M4 MA.. nicht bei eingeschaltetem Gerät montieren
Do not install M4 MA.. in TRIP position.



- Arbeitsstromsignal an M4 A.. maximal 10 Sekunden
Do not send a shunt signal more than 10 seconds to M4 A..

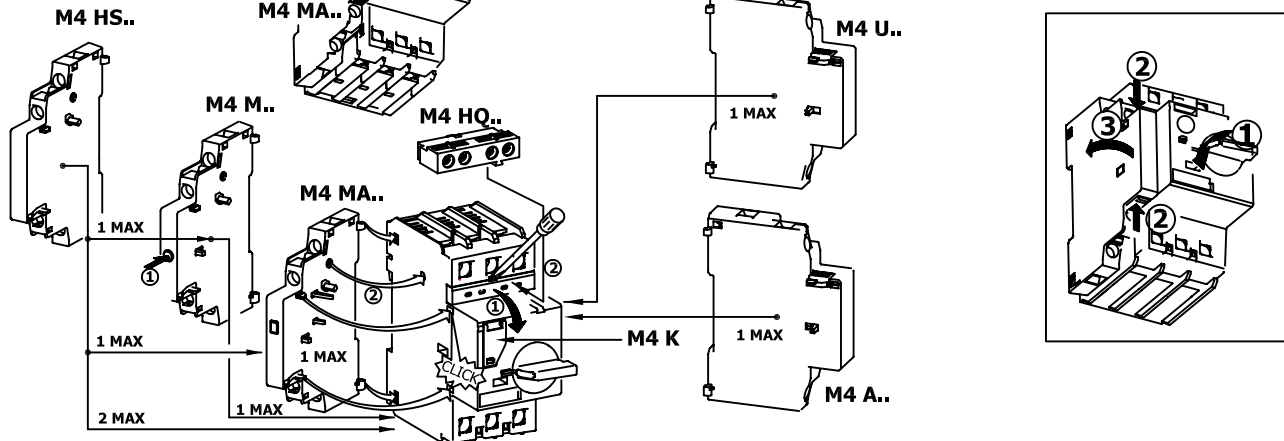

Installation

- M4-63R
- M4-100R/ M4-100RH

- M4 MA.. nicht bei eingeschaltetem Gerät montieren
Do not install M4 MA.. in TRIP position.



- Arbeitsstromsignal an M4 A.. maximal 10 Sekunden
Do not send a shunt signal more than 10 seconds to M4 A..

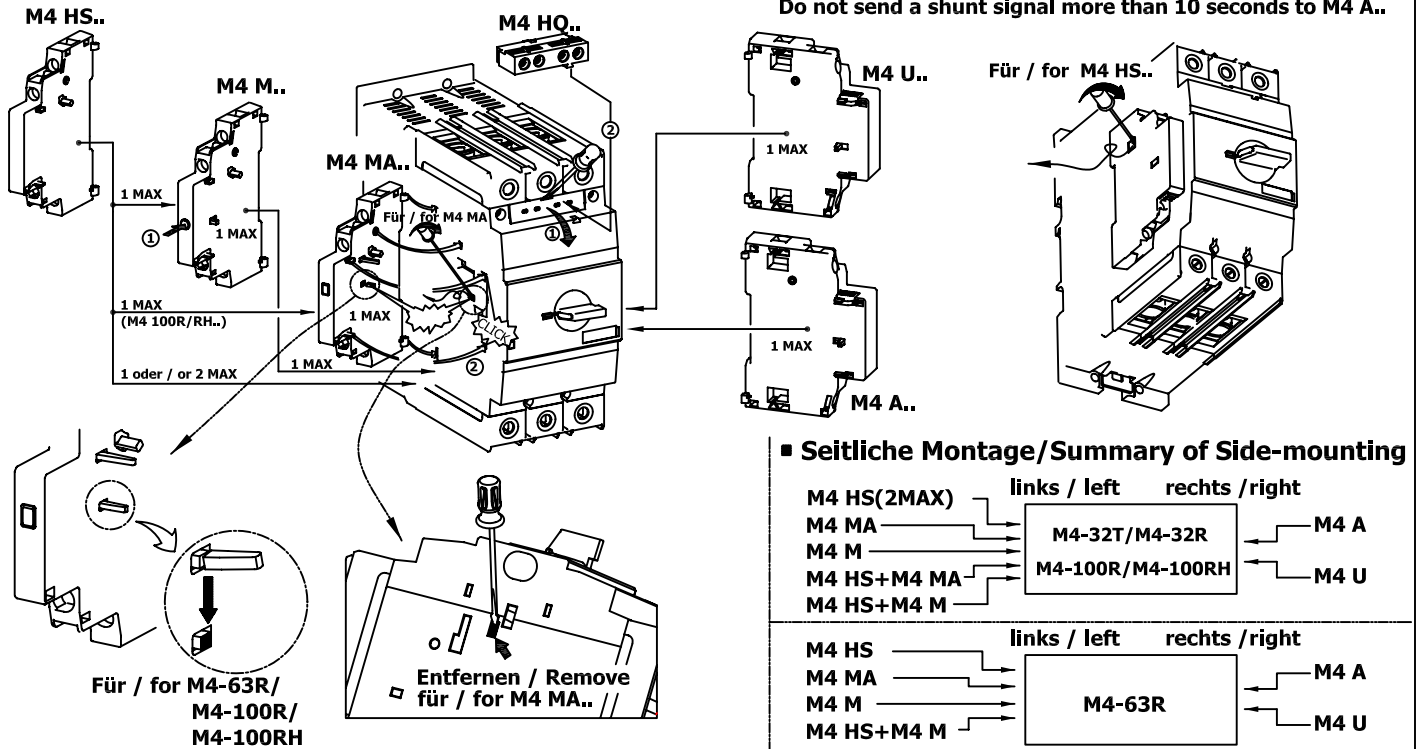

Seitliche Montage/Summary of Side-mounting

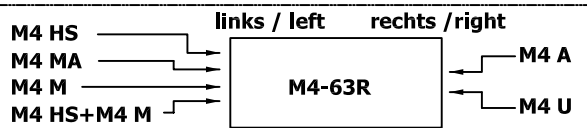
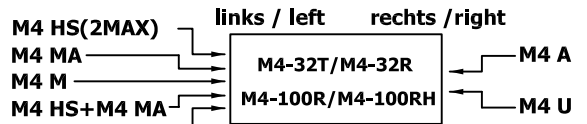

Zubehör / Accessory	Type	Ausführung / Specification
Hilfsschalter querlegend Front mounting Aux, S/W	M4 HQ11	1S 1Ø / 1NO 1NC
	M4 HQ20	2S / 2NO
	M4 HQ02	2Ø / 2NC
Hilfsschalter für seitlichen Anbau Side mounting Aux, S/W	M4 HS11	1S 1Ø / 1NO 1NC
	M4 HS20	2S / 2NO
	M4 HS02	2Ø / 2NC
Meldescharter Alarm S/W	M4 M11	1S 1Ø / 1NO 1NC
Kurzschlußschalter Short-circuit alarm S/W	M4 MA11	1S 1Ø / 1NO 1NC
Unterspannungsauslöser Under-voltage release	M4 U24	AC24V 50Hz/AC28V 60Hz
	M4 U110	AC110~127V 50Hz/AC120V 60Hz
	M4 U230	AC220~230V 50Hz/AC240~260V 60Hz
	M4 U240	AC240V 50Hz/AC277V 60Hz
	M4 U400	AC380~400V 50Hz/AC440~460V 60Hz
	M4 U415	AC415~440V 50Hz/AC460~480V 60Hz
Arbeitsstromauslöser Shunt release	M4 A24	AC24V 50Hz/AC28V 60Hz
	M4 A110	AC110~127V 50Hz/AC120V 60Hz
	M4 A230	AC220~230V 50Hz/AC240~260V 60Hz
	M4 A240	AC240V 50Hz/AC277V 60Hz
	M4 A400	AC380~400V 50Hz/AC440~460V 60Hz
	M4 A415	AC415~440V 50Hz/AC460~480V 60Hz

Zubehör / Accessory	Type	für / for
Klemmenblock für erhöhte Kriechstrecken Insulation Barrier	M4 100E	M4-100R/RH
DIN-Schienenadapter (für Direktstarter) Rail mounting adaptor (for DOL starter)	M4 32HU1	M4-32T/R
	M4 63HU1	M4-63R
	M4 100HU1	M4-100R/RH
Einsteckklaschen Mounting Plate	M4 32L	M4-32T/R
Skalenabdeckung Dial Cover	M4 K	M4-32T/R
		M4-63R M4-100R/RH